SCC 2005

Second North American Conference
on the Design and Use of
Self-Consolidating Concrete

Fourth International RILEM Symposium on
Self-Compacting Concrete

Edited by

Surendra P. Shah

Center for Advanced Cement-Based Materials
McCormick School of Engineering and Applied Science
Northwestern University

A Hanley Wood Publication

STRENGTH, SHRINKAGE AND CREEP OF SCC AND FLOWING CONCRETE

Mario Collepardi, Antonio Borsoi, Silvia Collepardi, Roberto Troli
Enco, Engineering Concrete, Ponzano Veneto (TV), Italy

ABSTRACT

A flowing concrete and two self-compacting concretes were manufactured, at a given Portland cement content (400 kg/m^3) and water-cement ratio (0.45), in order to obtain the same 28-day cube strength. Two mineral additions were used in producing SCC (ground limestone or fly ash). The dosage of a polycarboxylate-based superplasticizer was adapted to produce SCCs with a slump-flow of about 750 mm and a flowing concrete with a slump of 200 mm. Concrete specimens were wet cured at room temperature (20°C).

The compressive strength of SCCs were higher than that of the flowing concrete. This can be explained by the pozzolanic activity of fly ash in addition to the cement content; however, ground limestone is not a pozzolanic material and therefore its action can be related with a change in the microstructure of the cement matrix caused by the small particles of limestone. The change in the microstructure can also explain why the steel-bond strength is much higher in the two SCCs than in the flowing concrete. The drying shrinkage of the SCCs is substantially the same of that of ordinary flowing concrete, whereas creep is slightly higher in fly-ash SCC than in limestone-SCC or flowing concrete.

INTRODUCTION

Self-compacting concrete (SCC), or self-consolidating concrete in the USA, is a segregation-free concrete although it is so fluid that it can completely fill any area of the formwork in the absence of any compaction effort. The main characteristic of SCC is the higher cement matrix-aggregate ratio with respect to an ordinary concrete. In other words, the volume of cement matrix, responsible for the mobility of the concrete mixture, must be increased in order to push the aggregate under the gravity action or under the pressure of a pumping system. On the other hand, the volume of the aggregate, in particular the coarse aggregate, must be reduced in terms of both volume and maximum size, to improve the mobility and the segregation-resistance of the fresh mixture. Figure 1 summarizes these changes on a quantitative basis by comparing the volume of the ingredients in an ordinary concrete and in the corresponding SCC at the same water-cement ratio (w/c). The following rules should be followed to be successful in manufacturing SSC:

- the volume of the cement (V_c) + that of the fine powder (V_f) (fly ash, limestone filler, silica fume, and fine sand smaller 125 mm) should be in the range of $170\text{-}200 \text{ L/m}^3$;

- the water to cement + fine powder ratio by volume, $V_w / (V_c + V_f)$, should be in the range of 0.85-1.20;
- the volume of coarse aggregate should be lower than 340 L/m^3 ;
- the maximum size of the coarse aggregate should be smaller than 25mm, preferably 20 mm.

Excessive values of fine materials ($V_c + V_f$) make the mixture too viscous and reduce its mobility; on the other hand, values that are too low in ($V_c + V_f$) increase the segregation risk. Moreover, a value in $V_w / (V_c + V_f)$ higher than 1.20 increases the risk of segregation, whereas a value lower than 0.85 makes the fresh concrete too viscous. Volume and maximum size of the coarse aggregate must be lower than 340 L/m^3 and 25 mm respectively, in order to avoid segregation and collision among aggregate particles which can block the concrete flow.

Two chemical admixtures are needed to improve the mobility of the fresh concrete without excess in the V_w and to reduce the segregation risk without excess in the value of $V_c + V_f$. These admixtures are superplasticizer and viscosity modifying agent (VMA), respectively. Another important role of the VMA is to mitigate the segregation of the concrete on the occasion of an increase in the water content of the aggregates.

Due to these special proportions in its ingredients SCC could be characterized by relatively high drying shrinkage and creep since both these properties increase by increasing the cement matrix/aggregate ratio. These properties have been studied by Vieira and Bettencourt (1), Pons et al (2), Assié et al (3), Vitek (4) and Chopin et al (5). The purpose of the present work was to study the drying shrinkage and the creep, under the same exposure conditions, of two different SCCs (containing ground limestone or fly ash) with respect to an ordinary concrete (slump of about 200 mm) at a given w/c, and then presumably at the same compressive strength and other mechanical properties such as steel-concrete bond.

EXPERIMENTAL: MATERIALS AND METHODS

Materials

Durable concrete mixtures with a w/c of 0.45 were designed (Table 1). The composition of an ordinary flowing concrete (slump 200 mm) and that of two SCCs, with fly ash or ground limestone (0.1-45 mm) as fine mineral addition, were manufactured at a given cement content (400 kg/m^3) and at a given amount of mixing water (180 kg/m^3). The maximum size of the coarse aggregate for all the mixtures was 20 mm and therefore compatible with the above limit required by SCC.

The water-binder ratio (w/b) of the fly-ash-SCC (F-SCC) is 0.34 if one takes into account the amount of fly ash (135 kg/m^3) to act as a cementitious material. On the other hand, in the limestone-SCC (L-SCC), the aggregate/cement ratio is 4.5, and then it is higher than that of the F-SCC (3.1) and equal to that of the ordinary flowing concrete (OFC), if one considers the amount of ground limestone (160 kg/m^3) just as the finest fraction in the particle size distribution of the aggregate. Figure 1 shows the difference in the particle

size distribution of the aggregate used in the OFC (42% of sand; and 58% of gravel) and that adopted for the L-SCC (9% of ground limestone; 45 % of sand; and 46% of gravel).

Ingredients/Properties		MIX		
		OFC	L/SCC	F/SCC
CEM I 52.5R (kg/m ³)		400	400	400
Filler (kg/m ³)		----	Limestone 160	Fly Ash 135
Aggregate	Sand (0-4 mm) kg/m ³	760	785	785
	Gravel (4-20 mm) kg/m ³	1040	845	845
Water (kg/m ³)		180	180	180
Superplasticizer* (kg/m ³)		2,4	4,5	5,2
VMA** (% cem)		----	0,25	0,20
water/cement ratio		0,45	0,45	0,45 (0,34)****
aggregate/cement ratio		4,5	4,1 (4,5)***	4,1 (3,1)****
Slump (mm)		180	----	----
Slump flow (mm)		----	750	740

* Polycarboxylate-based superplasticizer

** VMA = Viscosity Modifying Agent

*** Within brackets the values with limestone as aggregate

**** Within brackets the values with fly ash as cementitious material

Table 1. Composition and workability of ordinary flowing concrete (OFC) and SCCs

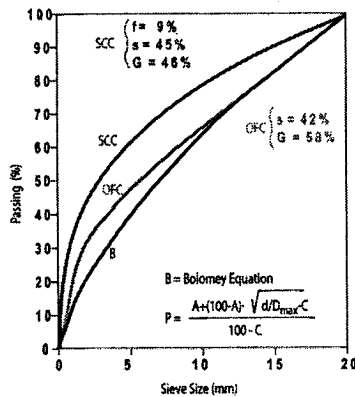

Figure 1. Particle size distribution of the aggregate in L/SCC or ordinary flowing concrete (OFC) in comparison with the Bolomey equation; f= ground limestone; s= sand; G = gravel

The amount of superplasticizer based on acrylic polymer was: 0.6% for OFC (slump = 200 mm); 1.1% for the L-SCC (slump flow = 750 mm); and 1.3 for the F-SCC (slump flow = 740 mm). The VMA was 0.25% for L-SCC and 0.20% for the F-SCC.

Figure 2 shows the volume of the two SCCs in comparison with that of the ordinary flowing concrete; with respect to this concrete the two SCCs contain more volume of fine material and less volume of the coarse aggregate, whereas there is no difference in the volume of cement, water, sand and air.

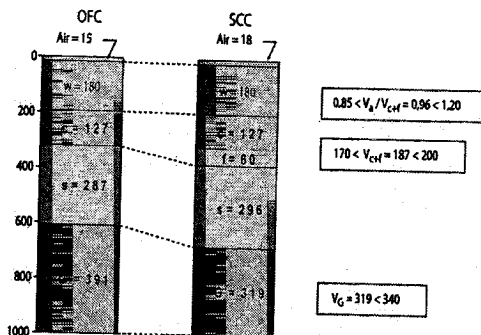

Figure 2. Composition in volume (L/m^3) of the ingredients in the ordinary concrete (OC) and SCC

Methods

The OFC was placed in cubic formworks and fully vibrated. The two SCCs were poured into the formworks without any vibration at all. All the concrete mixtures were wet cured at $20^\circ C$ and the compressive strength was measured from 1 day to 28 days.

Reinforced concrete specimens, devoted to the measurement of the steel-concrete bond, were manufactured as shown in Figure 3. Again the two SCCs were placed without any vibration, whereas for the OFC three vibration times were adopted: 0-15-30 seconds. These reinforced specimens were wet cured at $20^\circ C$ and then the steel-concrete bond was measured at 28 days by pulling-out the metallic bar as schematically shown in Fig. 3.

The specimens for shrinkage and creep tests were wet cured for 7 days at $20^\circ C$, and then exposed to unsaturated air (R.H. of 65%). Some specimens were kept up to 180 days to measure the drying shrinkage (ϵ_S) in the absence of any loading. Other specimens were loaded at 7 days under a compressive stress of about 14-17 MPa corresponding to 1/4 of the compressive strength at 7 days of each specimen. The elastic strain (ϵ_E), immediately after the loading at 7 days, was measured; then, the total strain (ϵ_T) as a function of the time from 7 to 180 days of the loaded specimens was measured in the air at R.H. of 65%. The creep strain (ϵ_C) was determined by subtracting ϵ_E and ϵ_S to the total strain (ϵ_T)

$$\epsilon_C = \epsilon_T - \epsilon_E - \epsilon_S \quad [1]$$

Some cement matrix was taken from the concrete specimens at 28 days and was examined by scanning electron microscopy in order to study the microstructure of the OFC in comparison with that of the two SCCs.

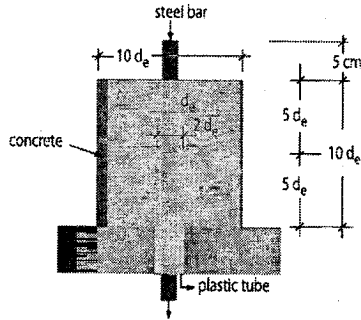

Figure 3. Reinforced specimen for the steel-concrete bond test according to RILEM-CEB

RESULTS

Compressive Strength

Figure 4 shows the compressive strength values at 1-3-7-21-28 days of the two SCCs in comparison with that of the OFC. At a given w/c of 0.45, the two SCCs were stronger (by about 20%) than the OFC at early and later ages. The mechanical behavior of the F-SCC could be expected on the basis of the pozzolanic activity of the fly ash. Indeed, the water-binder ratio of the F-SCC (0.34) is lower than that of the corresponding OFC at the same w/c of 0.45. On the other hand, the mechanical behavior of the L-SCC is surprising since limestone is not considered to act as a pozzolanic material. Therefore, its enhancing effect on the strength of the SCC, with respect to that of the corresponding OFC at equal w/c, should be ascribed to a physical rather than to a chemical effect. The fine particle of the ground limestone could act as filling material for the voids of the cement matrix in the SCC. On the other hand, fly ash could act as both filling and pozzolanic material and this could explain why the strength of the F-SCC is slightly higher than that of the corresponding L-SCC, particularly at early ages.

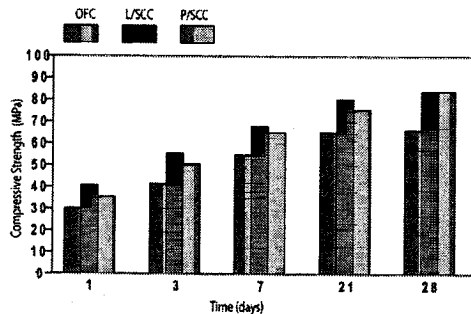

Figure 4. Compressive strength of OFC, L/SCC and F/SCC

Microstructure and Steel Bond

The microstructure of the cement matrix shown in Fig. 5-7 confirms the above hypothesis to explain the filling effect of the ground limestone. The presence of C-S-H based material on the surface of the fly ash particles (Fig. 7) indicates the pozzolanic effect in addition to the filling one. This microstructural characteristic can also explain why the

steel-bond of the two SCCs is much better (by about 70%) than that of the OFC (Fig. 8). Moreover, an excessive vibration (from 15 to 30 seconds) of the OFC reduces the steel-bond probably for the presence of the bleeding water at the interface of the steel-concrete interface: Fig. 9 schematically shows how the filling action of ground limestone or fly ash can improve the steel bond interface in SCC with respect to that of the OFC.

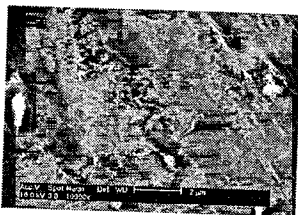

Figure 5. SEM micrograph of the cement matrix of OFC (by D. Salvioni, Mapei)



Figure 6. SEM micrograph of the cement matrix of L/SCC (by D. Salvioni, Mapei)

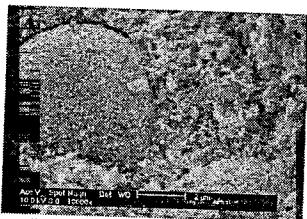

Figure 7. SEM micrograph of the cement matrix of F/SCC (by D. Salvioni, Mapei)

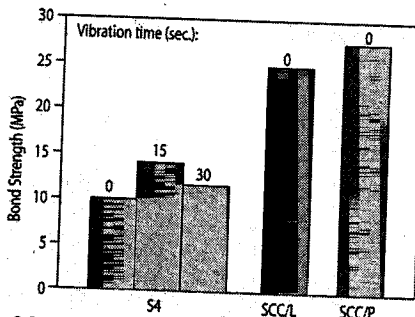

Figure 8. Steel bond-strength of OFC and SCCs. The figures indicate the vibration time.

Drying Shrinkage and Creep

Figure 10-12 show the strain of the three concretes exposed to drying shrinkage and permanent loading from 7 to 180 days when exposed to the air (R.H. of 65%) after an initial wet curing of 7 days. For each concrete the contributions to the total strain (ϵ_T) are separately shown in terms of:

- elastic strain (ϵ_E);
- drying shrinkage in the absence of any loading (ϵ_S);

- creep strain (ϵ_C) when loaded at 1/4 of the compressive strength at 7 days.

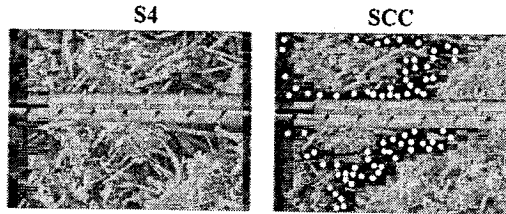

Figure 9. Schematic model of strength-concrete area in ordinary flowing concrete and in SCC

There is no significant difference in the behavior of the OFC and that of the L-SCC as far as the above strains are concerned. On the other hand, F-SCC shows a higher creep strain than that of the corresponding OFC, without any other difference for the elastic and shrinkage strains. Table 2 summarizes the different strains at 180 days of OFC, F-SCC and L-SCC. The higher creep strain of the F-SCC with respect to those of the other two concretes could be related with the presence of some cenosphere particles in the fly ash which could be deformed or destroyed under a permanent compressive loading (Fig. 13). On the other hand, the drying shrinkage is the same in OFC as well as in the two SCCs (470 micro-strains). The F-SCC has an aggregate-cement matrix ratio lower than that of the OFC (3.1 vs 4.5, as shown in Table 1) and it should be more prone to a higher drying shrinkage since this decreases by increasing the aggregate-cement matrix ratio; on the other hand, the dense microstructure of the cement matrix in F-SCC, related with the lower water-binder ratio (0.34 vs. 0.45, as shown in Table 1), could reduce the esiccation of the water in the cement matrix and then it could compensate the negative effect of the lower aggregate-binder ratio.

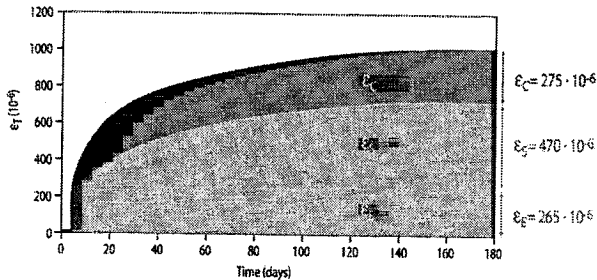

Figure 10. OFC: elastic strain (ϵ_E), drying-shrinkage (ϵ_S) and creep strain (ϵ_C) at R.H. of 65% with a load of 138 MPa at 7 days (1/4 of 55 MPa)

STRAIN (10^{-6})	OFC	L/SCC	F/SCC
ϵ_F	265	260	270
ϵ_S	470	470	470
ϵ_C	275	270	430
ϵ_T	1010	1000	1170

Table 2. Strains at 180 days in OFC and SCCs

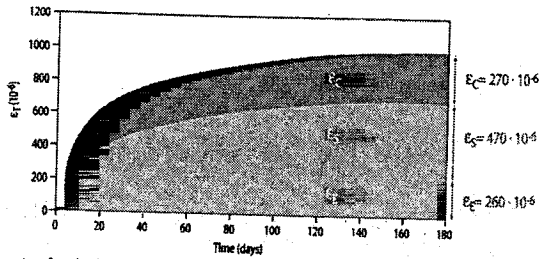

Figure 11. OFC: elastic strain (ϵ_E), drying-shrinkage (ϵ_S) and creep strain (ϵ_C) at R.H. of 65% with a load of 170 MPa at 7 days (1/4 of 68 MPa)

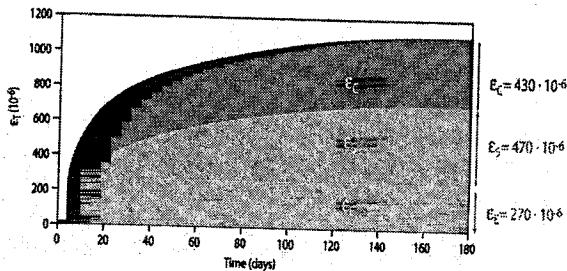

Figure 12. OFC: elastic strain (ϵ_E), drying-shrinkage (ϵ_S) and creep strain (ϵ_C) at R.H. of 65% with a load of 163 MPa at 7 days (1/4 of 65 MPa)

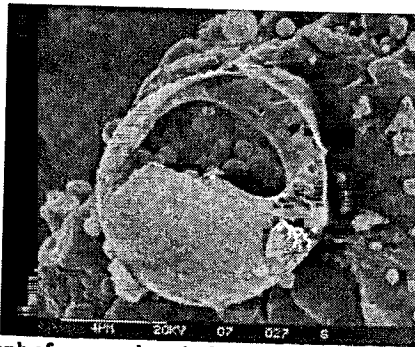

Figure 13. SEM micrograph of a cenosphere in fly ash

CONCLUSIONS

Two SCCs concretes (slump flow about 750mm) with fly ash or ground limestone as fine materials have been studied in comparison with the corresponding ordinary flowing concrete (slump of 200 mm) at the same w/c (0.45) and cement content (400 kg/m³). The results of the present work indicate that compressive strength and steel-bond strength in SCCs with fly ash or ground limestone are higher than in the corresponding ordinary flowing concrete. In particular, the absence of vibration in placing the SCCs significantly improves the steel-bond strength with respect to that of the OFC; the latter can be

damaged by an excessive vibration for the formation of bleeding water at the steel-concrete interface. The mechanical behavior of the SCC with respect to that of the ordinary flowing concrete could be ascribed to the filling effect of the fine particles of ground limestone or fly ash in the micro-voids of the cement matrix. The additional pozzolanic effect can explain why the strength of the fly-ash-SCC is slightly higher than that of the limestone-SCC.

Shrinkage and creep strains in limestone-SCC are approximately the same as those of the ordinary flowing concrete. On the other hand, the creep of fly-ash-SCC is higher than those of the other two concretes: this behavior could be ascribed to the presence of some cenospheres in the fly-ash-SCC which could be deformed by the permanent loading (1/4 of the strength at the time of loading).

REFERENCES

1. Manuel Vieira and Antonio Bettencourt, "Deformability of Hardened SCC", Proceedings of the 3rd International RILEM Symposium on Self-Compacting Concrete, Ed. O. Wallevik and I. Nielsson, 2003, pp. 637-644.
2. Gérard Pons, Erwan Proust and Stéphan Assié, "Creep and Shrinkage of Self-Compacting Concrete: A Different Behaviour Compared with Vibrated Concrete", Proceedings of the 3rd International RILEM Symposium on Self-Compacting Concrete, Ed. O. Wallevik and I. Nielsson, 2003, pp. 645-654.
3. Stéphan Assié, Gilles Escadeillas and Giuseppe Marchese, "Durability of Self-Compacting Concrete", Proceedings of the 3rd International RILEM Symposium on Self-Compacting Concrete, Ed. O. Wallevik and I. Nielsson, 2003, pp. 655-662.
4. Jan L. Vitek, "Long-Term Deformations of Self-Compacting Concrete", Proceedings of the 3rd International RILEM Symposium on Self-Compacting Concrete, Ed. O. Wallevik and I. Nielsson, 2003, pp. 663-671.
5. David Chopin, Olivier Francy, Simon Lebourgeois and Patrick Rougeau, "Creep and Shrinkage of Heat-Cured Self-Compacting Concrete (SCC)", Proceedings of the 3rd International RILEM Symposium on Self-Compacting Concrete, Ed. O. Wallevik and I. Nielsson, 2003, pp. 672-683.